SPLIT SYSTEM

TECHNICAL GUIDE

Split system - cooling only
Models SOC / SIC



Index

	Page		Page
General description	5		
<hr/>			
- Nomenclature	5	- Leakage detection	12
		- Refrigerant load	12
		- Adjusting the refrigerant load	12
		- Refrigerant interconnections	12
		- Diameter of the interconnecting tubing	13
		- Insulation of tubing	13
Technical specifications	5		
<hr/>			
- Mechanical specifications of outdoor units AHO-F	5	Wiring installation	13
- Mechanical specifications of indoor unit CHI-800	5	<hr/>	
- Table of variations	6	- Electrical characteristics	13 - 14
- Physical data	7	- Limits of use	14
- Rated performance data	8	- Before final approval of the installation	14
- Testing conditions	8		
- Correction factors	8	Instructions for use	15
- Cooling capacities sensitives	8 - 10	<hr/>	
- CHI-800 fan performance	10	- General information	15
		- Ambient thermostat	15
Installation instructions	11		
<hr/>			
- General comments	11	Maintenance	16
- Protection of the environment	11	<hr/>	
- Warning signals	11	- Filling the drainage siphon	16
- Transportation	11	- Discharge of the indoor units with ducts	16
- Location	11	- Cleaning the filters	16
- Empty spaces	11	- Cleaning the outdoor unit	16
- Air ducts (indoor unit)	12	- Checking the tension of the belts	16
- Drainage connections	12		
- Valves and refrigerant load	12	General dimensions	17 - 18
- Emptying and dehydrating	12	<hr/>	

General description

The units in the SOC range are the outdoor units of a split-type air conditioner; they are fitted with a vertical discharge axial fan and have been designed for installation outdoors. Units SOC-076 to 180 are compatible with indoor units SIC-076 to 60. In winter they can provide heat if the indoor unit SIC is fitted with an electric heater or a hot water coil (optional accessories).

The outdoor unit SOC-240 is compatible with the SIC-240. For operation, these units must be connected, electrically and with regard to the refrigerant, to the corresponding indoor unit.

Nomenclature

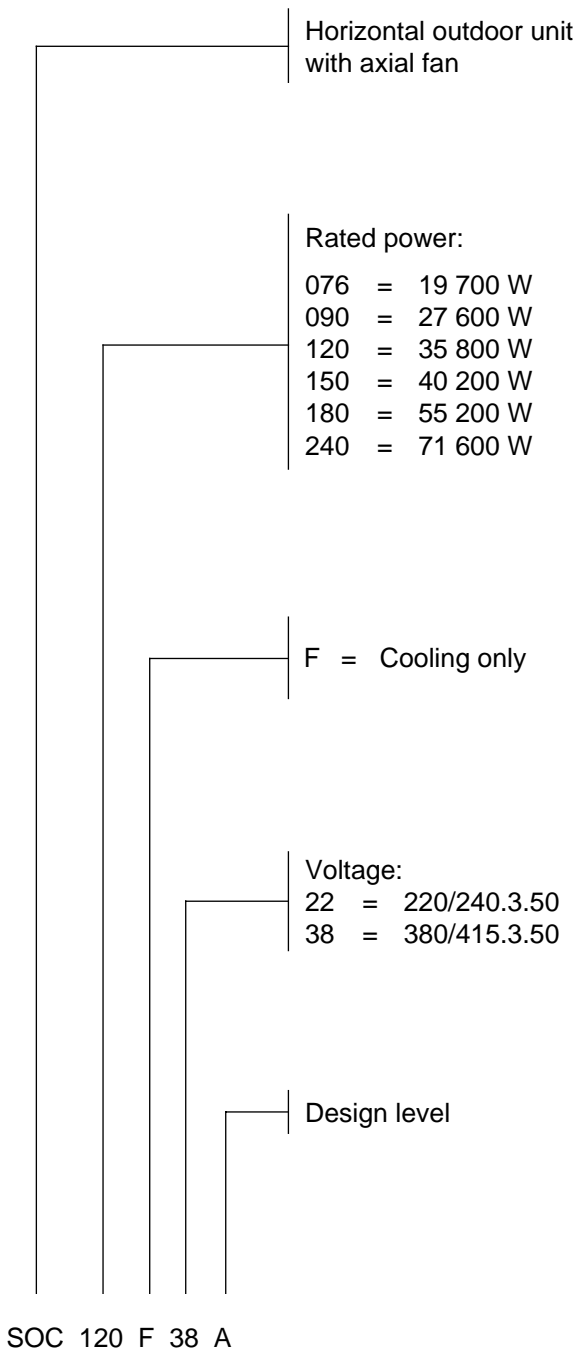

Technical specifications

Mechanical specifications of outdoor units SOC

Compressor

Vertical hermetic type, mounted on vibration isolators, with

oversized mechanical components and a low-consumption motor.

It is delivered with a charge of special oil which prevents the formation of foam, and with an oil heater element.

Models SOC-090 and SOC-180 incorporate Scroll rotary compressors. Remaining models incorporate reciprocating compressors.

Compressor heater

Keeps the crankcase oil hot to ease start-ups and prevent oil from being carried away from the compressor.

Coils

Large heat transfer area coils, made of copper tubes and 'slit' aluminium fins.

Fans

Axial fans with free air discharge, without ductwork. Quiet operation and three speeds available.

Casing

Made of aluminium-zinc galvanized steel sheet, finished with baked-on polymerized powder paint.

Refrigerant circuit

Made of brazed copper tubes.

Units are delivered dehydrated and after having passed the relevant pressure and leak detection tests.

Electrical and control wiring system

Highly reliable integrated circuits. Their compact size permit easy and fast servicing. It complies with the European regulations currently in force.

Mechanical specifications of indoor unit SIC-240

Indoor unit SIC-240 is compatible with either of the cool only outdoor units SOC-240 or heat pump SOH-240.

The main features of this unit are as follows:

Fan

Double fan type with common shaft, pulley and belt drive. The fan pulley is of the removable tapered core type.

The motor is mounted on a tensioner base which makes maintenance operations easier.

The fan motor assembly is resiliently mounted on spring isolators to avoid transmission of vibration and noises.

Coil

Made of copper tubes and aluminium 'slit' fins.

Control box

Fully accessible from outside.

Casing

Made of aluminium-zinc galvanized steel sheet highly resistant to corrosion, painted with baked-on epoxy-polyester powder enamel.

It features a shape framework which allows for all its components to be easily accessible.

It can take up an electric heater (optional accessory).

With integral filter rack and air filter.

Refrigerant circuit

Double circuit with directional connections and calibrated orifice type.

Table of variations

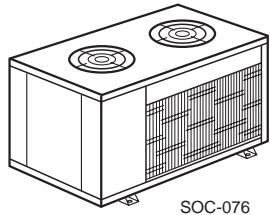

SOC-076
220/240.3.50
380/415.3.50

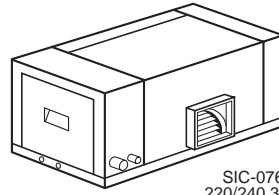

SIC-076
220/240.3.50
380/415.3.50

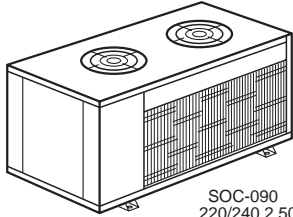

SOC-090
220/240.2.50
380/415.3.50

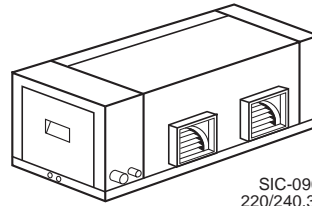

SIC-090/120
220/240.3.50
380/415.3.50

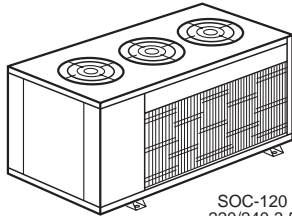

SOC-120
220/240.3.50
380/415.3.50

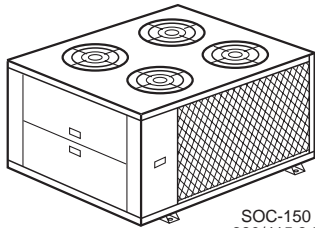

SOC-150
380/415.3.50

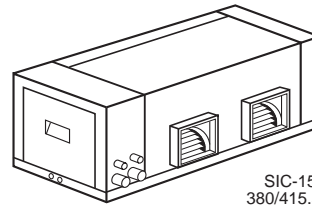

SIC-150
380/415.3.50

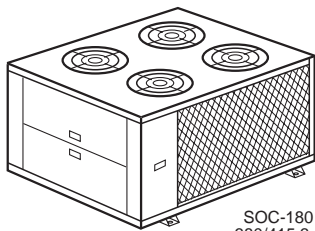

SOC-180
380/415.3.50

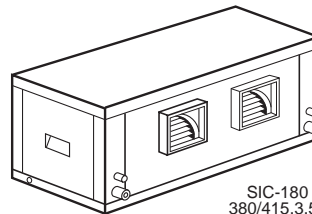

SIC-180
380/415.3.50

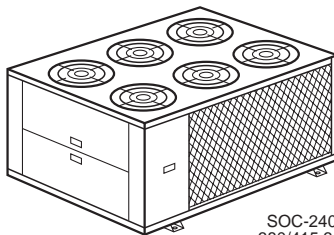

SOC-240
380/415.3.50

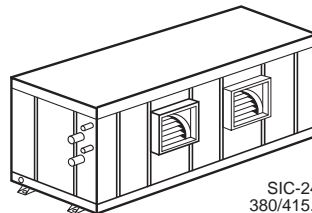

SIC-240
380/415.3.50

Physical data

Outdoor units

Model		SOC 076	SOC 090	SOC 120	SOC 150	SOC 180	SOC 240	
Compressor	Quantity	1	1	1	2	2	2	
	Type	Reciprocating	Scroll	Reciprocating	Reciprocating	Scroll	Reciprocating	
	Nominal power	kW	8.4	10.2	12.2	2 x 8.4	2 x 10.2	2 x 12.2
	Power supply	V.ph.Hz	220/240.3.50 or 380/415.3.50			380/415.3.50		
Outdoor fan	Power rating	W	216	216	216	216	216	
	Number of fans		2	2	3	4	6	6
	Power supply	V.ph.Hz.	220/240.1.50					
	Propeller width		510	510	510	510	510	510
Indoor coil	Quantity		2	2	2	2	2	
	Rows deep x high		4 x 28	4 x 28	4 x 28	4 x 56	4 x 56	4 x 56
	Tube O. D.		3/8"	3/8"	3/8"	3/8"	3/8"	3/8"
Shipping dimensions of outdoor unit	High	mm	1 030	1 030	1 030	1 495	1 495	1 495
	Wide	mm	1 580	1 860	2 230	1 690	1 975	2 150
	Deep	mm	950	950	950	1 547	1 547	1 547
Net weight	Kg	250	292	330	590	715	750	
Gross weight	Kg	259	302	340	595	720	755	

Indoor units

Model		SIC 240	
Fan	*Number of fan wheels	2	
	Wheel width	mm	380
	Long	mm	380
	*Motor power rating	W	3 000
	Nominal flow rate	m ³ /h	14 240
		m ³ /s	3.95
	Available pressure	mm WG	10
Pa		98	
Coil	Rows deep x high	4 x 33	
	Tube O. D.	3/8"	
Net weight	kg	337	
Gross weight	kg	427	

*A single motor drives the fan wheels.

Rated performance data

Outdoor unit	Indoor unit	Summer		Available pressure indoor blower Pa
		Cooling capacity W	Consumption W	
SOC-076	SIC-076	19 700	9 120	62
SOC-090	SIC-090/120	27 600	11 200	62
SOC-120	SIC-090/12	35 800	14 000	62
SOC-150	SIC-150	40 200	17 400	80
SOC-180	SIC-180	55 200	22 400	80
SOC-240	SIC-240	71 600	28 000	80

Note: SIC units have their own information available.

Testing conditions

Voltage V.	Length of interconnection line	Summer			
		Outdoor temperature °C		Indoor temperature °C	
		DB	WB	DB	WB
400	7.5 metres	35	24	27	19

Note: DB = Dry Bulb, WB = Wet Bulb.

Correction factors

Correction factors for cooling capacities

Cooling capacity correction factors according to indoor and outdoor temperatures.

% Flow rate	80	90	100	110	120	130
Total capacity	0.960	0.980	1	1.016	1.032	1.046
Sensible capacity	0.945	0.973	1	1.038	1.075	1.118
Comp. power input	0.980	0.990	1	1.009	1.017	1.025

Correction of the real entering outdoor coil air temperature for flow rates other than nominal.

% Flow rate	70	80	90	100	110	120	130
Correction in °C over the real entering outdoor coil air temperature	5	3	1.5	0	-1	-2	-2.5

Cooling capacities sensitives

Model	Outdoor air dry temperature °C (DB)	Air intake humid temperature °C (WB)	Total capacity W/h	Sensitive capacity (W/h)				Compressor absorbed power kW
				Temperautre air going to indoor unit °C (DB)				
				22	24	27	29	
SOC-076/ SIC-076	25	22	23 640	7 077	10 212	14 915	18 054	5.72
		19.5	21 276	11 006	14 141	18 844	21 276	5.99
		17	19 700	15 157	18 292	19 700	19 700	6.27
	35	22	21 867	6 490	9 625	14 328	17 463	6.47
		19.5	19 700	10 435	13 570	18 273	19 700	6.81
		17	18 124	13 687	16 823	18 124	18 124	7.15
	45	22	19 700	5 835	8 971	13 674	16 809	7.49
		19.5	17 730	9 782	12 918	17 621	17 730	7.83
		17	16 154	13 756	16 154	16 154	16 154	8.17

Cooling capacities sensitives

Model	Outdoor air dry temperature °C (DB)	Air intake humid temperature °C (WB)	Total capacity	Sensitive capacity (W/h)				Compressor absorbed power
				Temperature air going to indoor unit °C (DB)				
				22	24	27	29	
			W/h	W/h	W/h	W/h	W/h	kW
SOC-090/ SIC-090/120	25	22	34 800	10 426	15 008	21 879	26 466	6.24
		19.5	31 320	16 167	20 748	27 619	31 320	6.54
		17	29 000	22 233	26 814	29 000	29 000	6.84
	35	22	32 190	9 561	14 142	21 014	25 595	7.06
		19.5	29 000	15 325	19 906	26 777	29 000	7.43
		17	26 680	20 062	24 643	26 680	26 680	7.80
	45	22	29 000	8 597	13 178	20 050	24 631	8.17
		19.5	26 100	14 363	18 944	25 816	26 100	8.54
		17	23 780	20 168	23 780	23 780	23 780	8.92
SOC-120/ SIC-090/120	25	22	39 600	12 050	16 631	23 503	28 091	9.63
		19.5	35 640	17 763	22 344	29 215	33 804	10.08
		17	33 000	23 855	28 436	33 000	33 000	10.54
	35	22	36 630	11 041	15 622	22 493	27 074	10.89
		19.5	33 000	16 783	21 364	28 236	32 817	11.46
		17	30 360	21 363	25 944	30 360	30 360	12.03
	45	22	33 000	9 917	14 499	21 370	25 951	12.61
		19.5	29 700	15 665	20 246	27 118	29 700	13.18
		17	27 060	21 459	26 040	27 060	27 060	13.75
SOC-150/ SIC-150	25	22	48 240	14 518	20 628	29 793	35 911	12.14
		19.5	43 416	22 164	28 274	37 438	43 416	12.72
		17	40 200	30 264	36 374	40 200	40 200	13.29
	35	22	44 622	13 310	19 420	28 584	34 694	13.73
		19.5	40 200	20 989	27 099	36 264	40 200	14.45
		17	36 984	27 253	33 363	36 984	36 984	15.17
	45	22	40 200	11 964	18 074	27 239	33 349	15.90
		19.5	36 180	19 648	25 758	34 922	36 180	16.62
		17	32 964	27 386	32 964	32 964	32 964	17.34

Cooling capacities sensitives

Model	Outdoor air dry temperature °C (DB)	Air intake humid temperature °C (WB)	Total capacity	Sensitive capacity (W/h)				Compressor absorbed power
				Temperature air going to indoor unit °C (TS)				
				22	24	27	29	
			W/h	W/h	W/h	W/h	W/h	kW
SOC-180/ SIC-180	25	22	64 800	19 662	27 333	38 841	46 524	12.60
		19.5	58 320	29 237	36 909	48 417	56 102	13.20
		17	54 000	39 432	47 104	54 000	54 000	13.80
	35	22	59 940	18 017	25 689	37 197	44 869	14.25
		19.5	54 000	27 641	35 313	46 820	54 000	15.00
		17	49 680	35 362	43 034	49 680	49 680	15.75
	45	22	54 000	16 187	23 859	35 367	43 039	16.50
		19.5	48 600	25 819	33 491	44 999	48 600	17.25
		17	44 280	35 525	43 197	44 280	44 280	18.00
SOC-240/ SIC-240	25	22	81 600	24 781	34 373	48 762	58 368	19.65
		19.5	73 440	36 750	46 343	60 732	70 340	20.58
		17	68 000	49 500	59 092	68 000	68 000	21.52
	35	22	75 480	22 707	32 300	46 688	56 281	22.22
		19.5	68 000	34 737	44 330	58 718	68 000	23.39
		17	62 560	47 088	56 681	62 560	62 560	24.56
	45	22	68 000	20 400	29 992	44 381	53 973	25.73
		19.5	61 200	32 441	42 033	56 422	61 200	26.90
		17	55 760	44 575	54 168	55 760	55 760	28.07

SIC-240 fan performance

Model	Available static pressure		Air flow rate		Power input
	mm WG	Pa	m³/h	m³/s	W
SIC-240	19.9	195	10 000	2.78	1 395
	18	176	11 000	3.05	1 550
	16.1	158	12 000	3.33	1 565
	13.4	131	13 000	3.61	1 905
	10.7	105	14 000	3.89	2 050
	7.4	73	15 000	4.16	2 240
	3.9	38	16 000	4.44	2 430
	0	0	17 000	4.72	2 675

Installation instructions

General comments

The SOC series units are outdoor units of a split air conditioner which are equipped with an axial and vertical discharge fan, and are to be installed directly outdoors. For operation, these units must be connected, electrically and with regard to the refrigerant, to the corresponding indoor unit.

Protection of the environment



Packing

The packing material is recyclable. It should be disposed of in accordance with the residual collection regulations established.



Disposal of the unit



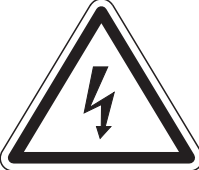

After a long service life, and upon disassembling the unit, its components should be recuperated ecologically. The cooling circuit is full of HCFC-22 refrigerant that should be salvaged and, finally, returned to the gas manufacturer for recycling. Oil will remain in the airtight compressor and, therefore, it will be returned along with the sealed circuit.

The air conditioning unit will be deposited wherever established by the local authorities for its selective disposal.

Warning signals

The following signs indicate the presence of potentially dangerous conditions for users or service personnel. Whenever found on the unit itself, keep in mind the warning indicated by each one.

	This sign indicates an electrical risk or danger.
	Attention: The unit has a remote control system and can start automatically. Two minutes prior to having access to the interior, the power supply should be disconnected so as to avoid any contact with the fan turbine.
	Attention: It is compulsory to read the instructions prior to any handling.

	Attention: Fan in operation.
	Attention: No to touch hot surfaces.
	Attention: Possible gas leakage due to inadequate handling.
	Attention: Transmission by belt and pulley.

Transportation

The outdoor units should always be transported in vertical position so as to avoid oil leakage from the compressor. If, for any reason, this position has to be changed, it should be done only for the time strictly necessary.

Location

The location chosen should allow permanent access for service maintenance, either through the side panels or the rear panel.

The outdoor unit should be installed directly outdoors.

Empty spaces

Empty space should be left in the installation of each unit for the following:

- a) Outdoor unit air intake and discharge.
- b) Connection of the drainage tubing and wiring.
- c) Air ducts.
- d) Maintenance service.
- e) Electrical supply.

For proper operation, the minimum distances indicated in the general dimensions drawings should always be respected with regard to obstacles that could obstruct the free circulation of air, or any service work.

Air ducts (indoor unit)

- 1.- Connect the ducts, isolating from the unit by means of a flexible hose, preferably of a non-combustible material, so as to avoid transmitting the vibration of the unit itself. If the ducts are made of flexible material they do not transmit vibrations.
- 2.- It is advisable to place a damper at each discharge duct derivation so as to be able to carry out a correct balance of the system.
- 3.- Make sure there is easy access for cleaning and changing the air filters.

Drainage connections

Install the drainage tubing of each tray through a siphon. Leave a minimum height difference of 75 mm. between the height of the connection to the unit and the line after the siphon (see figure). This is to avoid that the pressure drop produced by the fan may not interfere with the emptying of the tray. There should be an access so that, at the beginning of each season, the siphon may be filled with water. The drainage line should have a minimum inclination of 2 cms. per meter of total length.

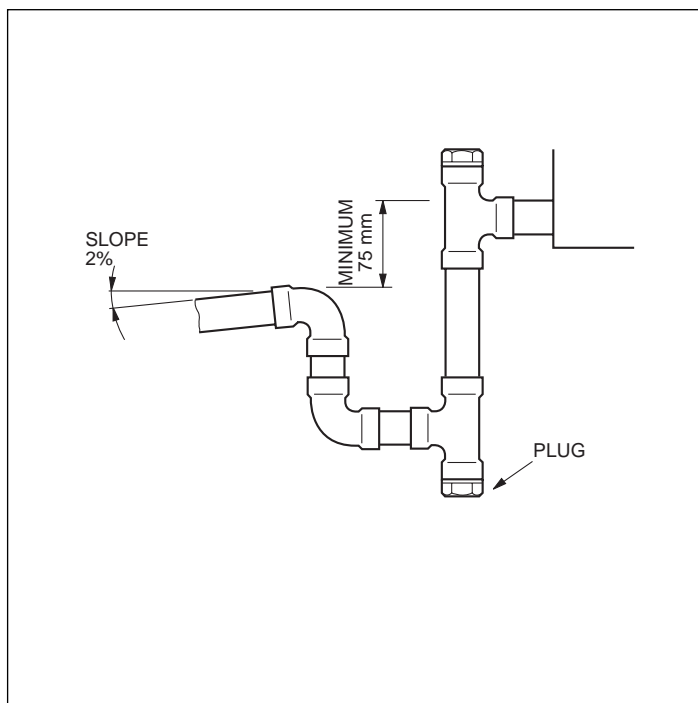

Valves and refrigerant load

The SOC-076 unit has only one circuit and is supplied with two valves. The SOC-150 unit has two circuits and is supplied with four valves. These valves are supplied closed and with an entire refrigerant load in the outdoor unit (pump-down). Before starting the unit, make sure the valves are completely open. The SOC-090 and SOC-120 units have only one circuit while the SOC-180 and SOC-240 units have two circuits. These units are supplied without valves, but with connections ready for welding. The refrigerant load must be carried out completely on site. See refrigerant load in the corresponding section, and follow the recommendations made in the Refrigerant Interconnections and Refrigerant Load Process sections.

Emptying and dehydrating

Air does not act as a refrigerant as it cannot be liquified by the compressor. The air and humidity remaining in the cooling

system should be completely eliminated, as these have undesirable effects, as indicated in the list below.

- High pressure increase.
- Power consumption increase.
- Equipment performance decrease.
- The water contained in the air may freeze and block the capillaries.
- The water may corrode certain parts of the circuit and deteriorate the compressor.

Emptying and dehydration should be carried out by means of a vacuum pump.

The vacuum needed is 200 microns (0.2 mm. Hg.).

Connection of the vacuum pump to the cooling circuit should be made at the 1/4" SAE connections furnished for this purpose, and with the valves closed.

This will allow emptying and dehydrating the units and interconnecting tubing.

The SOC-076 and SOC-150 units are supplied preloaded with refrigerant and does not need to be emptied.

Leakage detection

Leakage detection in the circuit that joins the two units will be carried out by using R-22 refrigerant and the aid of a detector.

Refrigerant load

The nominal refrigerant load is calculated for a tubing length of 7.5 meters.

Model	Nominal load R-22 kg	Number of circuits	Diameter liquid line	Additional load grs. (per meter)
SOC-076/SIC-076	7.1	1	1/2" (12.7 mm)	104
SOC-090/SIC-090/120	9.4	1	5/8" (15.87 mm)	170
SOC-120/SIC-090/120	11.45	1	5/8" (15.87 mm)	170
SOC-150/SIC-150	7	2	1/2" (12.7 mm)	104
SOC-180/SIC-180	9	2	5/8" (15.87 mm)	170
SOC-240/SIC-240	11.5	2	5/8" (15.87 mm)	170

Adjusting the refrigerant load

For lengths of tubing of over or under 7.5 m., the nominal refrigerant load should be increased or decreased by the grammes indicated above, in accordance to as to whether the length of the liquid tubing has been increased or decreased.

Refrigerant interconnections

When installing the tubing that interconnect both units, take special care in keeping the tubing to be used clean and dry prior to installation. The following recommendations are advisable:

- 1- Use only refrigerant quality copper tubing.
- 2- Do not work outdoors in the rain.
- 3- The ends of the tubing should remain closed during installation.
- 4- Do not leave neither the drying filters nor the compressor out in the open for more than one or two minutes.
- 5- For welding use low-solidus point rods with a minimum 5% silver content.
- 6- When welding, and while the tubing is still hot, a flow of dry nitrogen should be maintained so as to avoid the forming of oxides and scales in the interior which could cause

contamination and obstructions.

7- For copper-copper joints do not use strippers.

Diameter of the interconnecting tubing

Model	Diameter gas line (wide tubing)	Diameter liquid line (narrow tubing)
SOC-076 & 150	1 1/8" (28.5 mm)	1/2" (12.7 mm)
SOC-090, 120, 180 & 240		5/8" (15.87 mm)

Insulation of tubing

The gas tubing (wide tubing) should be isolated from the refrigerant. The insulation should have specific characteristics: be easy to install, resistant to aging, waterproof, fireproof and have a thickness of at least 12 mm.

So as to avoid deterioration due to the sun, it is convenient to paint same with water-based enamel.



CAUTION

After having insulated the tubing, do not attempt to bend it excessively as it could crack or break.

Wiring installation

The air conditioners are supplied with a control box to which the power supply is to be connected through a main switch with fuses, or an automatic switch.

The electric resistances, if any, should be connected to independent power supplies and switches, and not to the ones that feed the unit.

In every case the **established national regulations** should be applied.

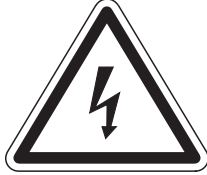

Loose cables can cause overheating of the terminals, or incorrect operation of the unit. A fire hazard may also exist. Therefore, make sure that all cables are connected tightly.

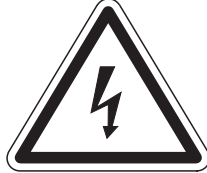

Do not supply power to the unit and do not start up operations until the tubing and electrical connections with the outdoor unit have been completed.
Make sure that the electrical supply is correctly connected to the units, as shown in the wiring diagrams.

Electrical characteristics

Outdoor units

Model	Power supply V.ph.Hz.		Consumption A					Power supply cable section mm ²	Automatic Switch A
	Compressor	Fan	Compressor			Fan			
			Start	Nominal	Maximum	Start	Nominal		
SOC-076	220/240.3.50	220/240.1.50	183	23.3	27.3	7	2.4	10	50
	380/415.3.50	220/240.1.50	91	13.5	15.8	7	2.4	6	32
SOC-090	220/240.3.50	220/240.1.50	170	25.6	30.6	7	2.2	16	63
	380/415.3.50	220/240.1.50	105	14.8	17.7	7	2.2	10	40
SOC-120	220/240.3.50	220/240.1.50	267	36.5	42.5	12	3.4	25	80
	380/415.3.50	220/240.1.50	135	21.1	24.6	12	3.4	10	50
SOC-150	380/415.3.50	220/240.1.50	2 x 91	2 x 13.5	2 x 15.8	2 x 7	2 x 2.2	16	63
SOC-180	380/415.3.50	220/240.1.50	2 x 105	2 x 14.8	2 x 17.7	2 x 7	2 x 2.3	25	100
SOC-240	380/415.3.50	220/240.1.50	2 x 135	2 x 21.1	2 x 24.6	2 x 12	2 x 3.4	25	100

Indoor units





Model	Power supply V.ph.Hz.		Consumption A		Power supply cable section mm ²	Automatic switch A
	Fan		Fan			
			Start	Nominal		
SIC-076	220/240.3.50		14	5,2	4 x 2.5	-
	380/415.3.50		7	2	4 x 2.5	-
SOC-090/SIC-090/120	220/240.3.50		23	5.5	4 x 2.5	-
	380/415.3.50		10	3.2	4 x 2.5	-
SOC-120/SOC-090/120	220/240.3.50		23	5.7	4 x 2.5	-
	380/415.3.50		10	3.3	4 x 2.5	-
SIC-150	380/415.3.50		10	3.5	4 x 2.5	-
SIC-180	380/415.3.50		27	7.1	4 x 2.5	15
SIC-240	380/415.3.50		30	6.4	4 x 2.5	15

Limits of use

Voltage limits				Air intake temperature to evaporating unit °C				Air intake temperature to condensing unit °C	
Nom. 220/240 V		Nom. 380/415 V		Temperature WB		Temperature DB		Temperature DB	
Minimum	Maximum	Minimum	Maximum	Minimum	Maximum	Minimum	Maximum	Minimum	Maximum
198	254	342	436	14	23	19	32	19	46

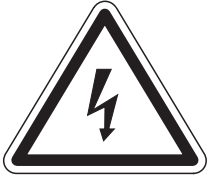
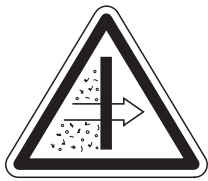
Notes: WB -Wet Bulb, DB -Dry Bulb.

Before final approval of the installation

	<p>Verify:</p> <ul style="list-style-type: none"> - Voltage is always between 198-254 V., or 342-436 V. - The section of the power supply cable is, at least, that recommended in the corresponding wiring diagrams. 		- The need to clean the air filter periodically has been notified.
	- Condensation drainage is carried out perfectly and there are no leaks in the water circuit.		<ul style="list-style-type: none"> - The guarantee card has been filled out. - Maintenance instructions have been given, or a regular servicing contract has been signed.
	- Operating instructions have been given to the user.		

Instructions for use

General information

The start up and automatic temperature setting is carried out by means of the ambient thermostat, at 24 volts, specially designed for these units.

Depending upon the model of your air conditioner, same will be controlled by the corresponding thermostat. The thermostat models may be: T-11 (one cooling phase and one heating phase), T-12 (one cooling phase and two heating phases), T-22 (two cooling phases and two heating phases). The instruction manual will allow you to become familiar with the operation of any and all of these.

Ambient thermostat

The thermostat for the SOC air conditioners are designed to give a correct ambient temperature control, and have all necessary controls for start up, stopping, selection and automatic temperature setting. It is equipped with a thermometric indicator that permanently shows the ambient temperature of the room being conditioned.

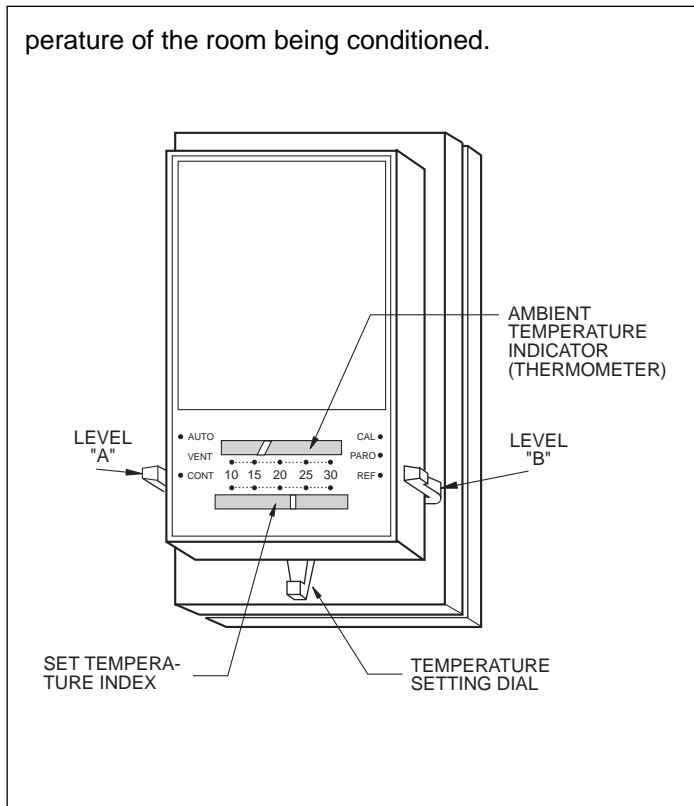

T-11 and T-12 thermostat

Starting process for the T-11 and T-12 thermostats

The thermostat has three basic operating modes:

- a) **For ventilating only:**
Lever A set to CONT.
Lever B set to OFF.
Dial at any setting.
- b) **Summer air conditioning (cooling):**
Lever A set to CONT or AUTO.
Lever B set to REF.
Dial set to the desired temperature index.
- c) **Winter air conditioning (heating):**
(with heating battery, optional accessory)
Lever A set to CONT or AUTO.
Lever B set to CAL.

Dial set to the desired temperature index.

In the "OFF" position the cooling unit is inoperative. When lever A is set to "CONT", only the fan operates. At the "REF" or "CAL" and "AUTO" settings, the fan starts to operate simultaneously with the compressor or the electric heater, if installed (optional accessory), in accordance with the thermostat index and the ambient temperature. The unit is completely inoperative when lever A is set to "AUTO" and lever B to "OFF".

Starting process for the T-22 thermostat

The thermostat has three basic operating modes:

- a) **For ventilating only:**
Lever A set to ON.
Lever B set to OFF.
Dial at any setting.
- b) **Summer air conditioning (cooling):**
Lever A set to ON.
Lever B set to COOL.
Dial set to the desired temperature index.
- c) **Winter air conditioning (heating):**
(with heating battery, optional accessory)
Lever A set to ON.
Lever B set to HEAT.
Dial set to the desired temperature index.

In the "OFF" position the cooling unit is inoperative. When lever A is set to "ON", only the fan operates. At the "COOL" or "HEAT" and "AUTO" settings, the fan starts to operate simultaneously with the compressor or the electric heater, if installed (optional accessory), in accordance with the thermostat index and the ambient temperature. The unit is

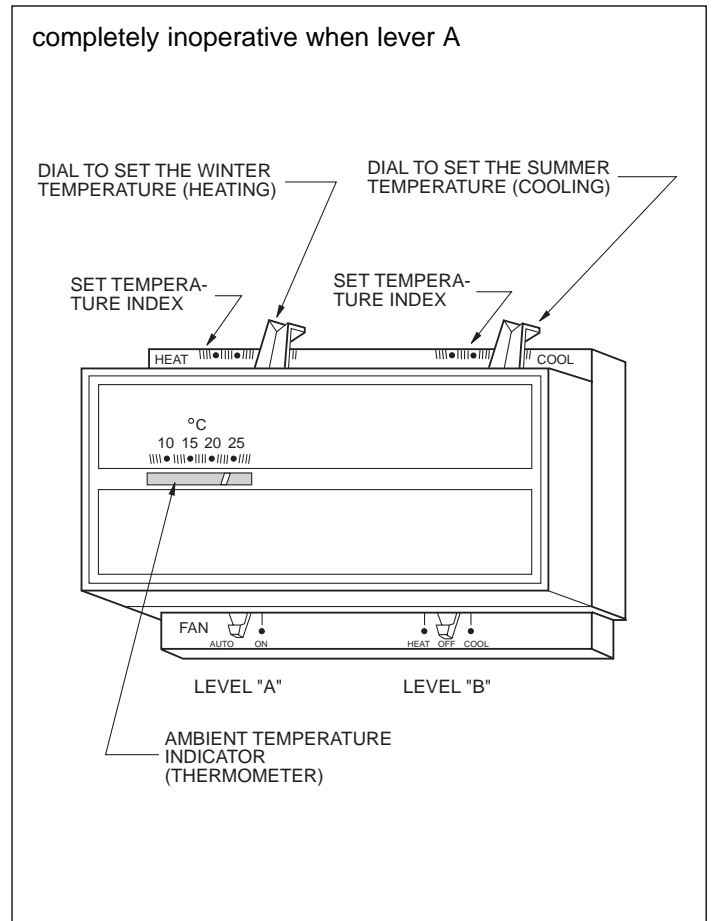

is set to "AUTO" and lever B to "OFF".

T-22 thermostat Maintenance

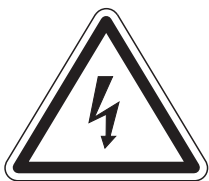

Clean the casing and the grill of the indoor unit either with

a vacuum cleaner or a rag soaked in a soft liquid detergent. Do not use water to clean the indoor unit. Water may damage the internal components and cause electrical discharges.

Filling the drainage siphon

So as to avoid having problems with the condensed water, we recommend that, prior to start up and before the beginning of each season, the drainage siphon be filled with water so as to avoid air being sucked in through this tubing.

Discharge of the indoor units with ducts



CAUTION

The discharge of the indoor units equipped for ducts are supplied without a protecting grill. When carrying out

maintenance services, keep this in mind.

In the case of installing an indoor unit with free discharge and equipped for ducts, the outlet opening should be protected with a grill. The lack of this protection could provoke damage caused by the fan turbine.

Cleaning the filters

Keep the battery filters in good condition, checking them at least once a month. If the filters are dirty, air flow and equipment performance are reduced.

Cleaning the outdoor unit



CAUTION

Dirt should not be allowed to accumulate in the outdoor battery. It should be cleaned as frequently as needed,



CAUTION

with a brush, vacuum cleaner or detergent.

For safety reasons, make sure to turn the air conditioner off, and unplug the power supply, prior to cleaning.

Check the outdoor unit periodically to see if the air inlet or outlet are clogged by dirt or leaves, etc.

The internal coil and other components of the outdoor unit must also be periodically cleaned. Contact your concessionary or maintenance service.

Checking the tension of the belts

The tension and wear of the belts of the motors should be



CAUTION

checked, and the belts changed if necessary. Before carrying this operation out, disconnect the main supply switch.

For safety reasons, make sure to turn the air conditioner off, and unplug the power supply, prior to checking the fan motor belts.

General dimensions mm

SIC-240

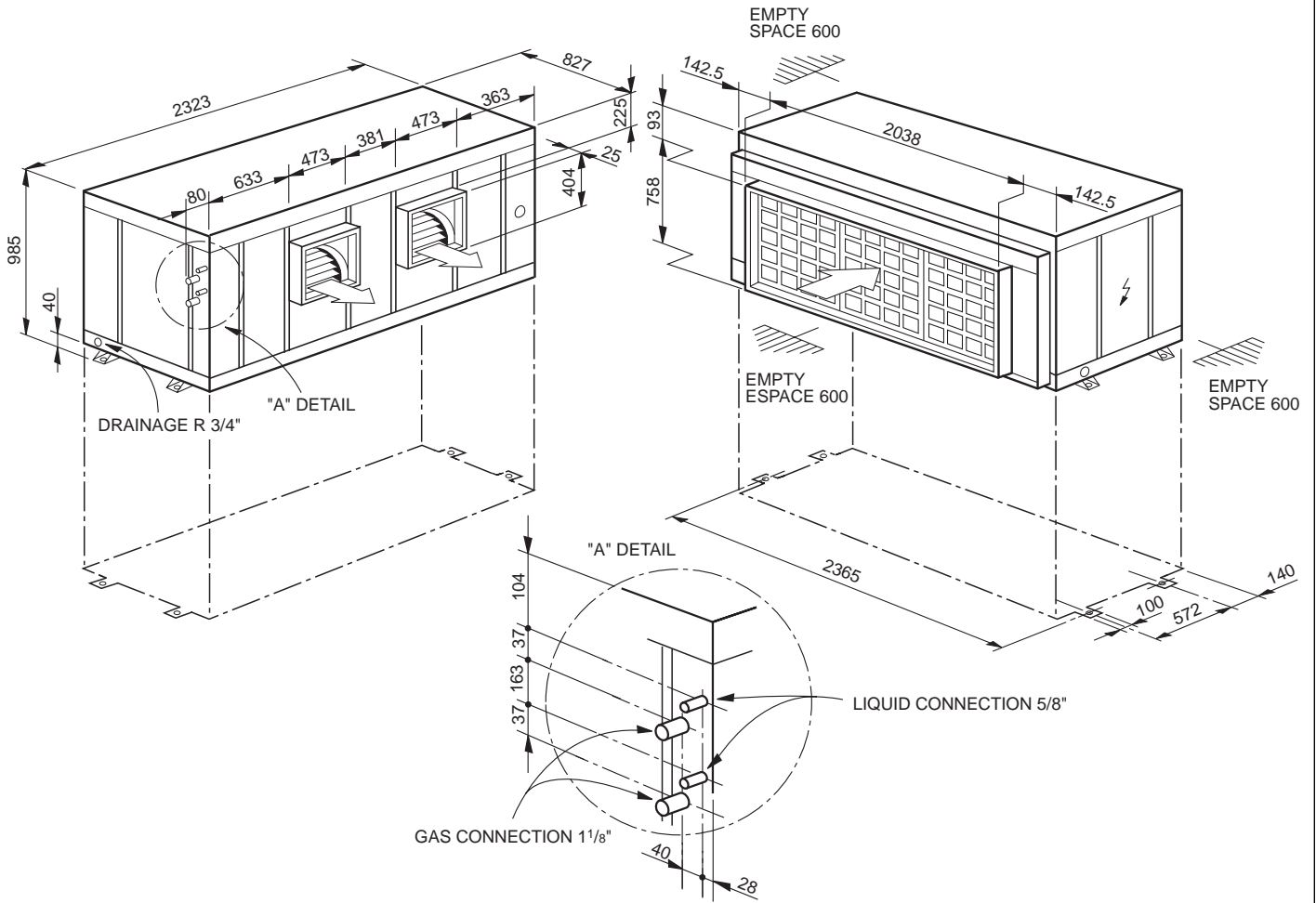

SOC-076, 090 & 120

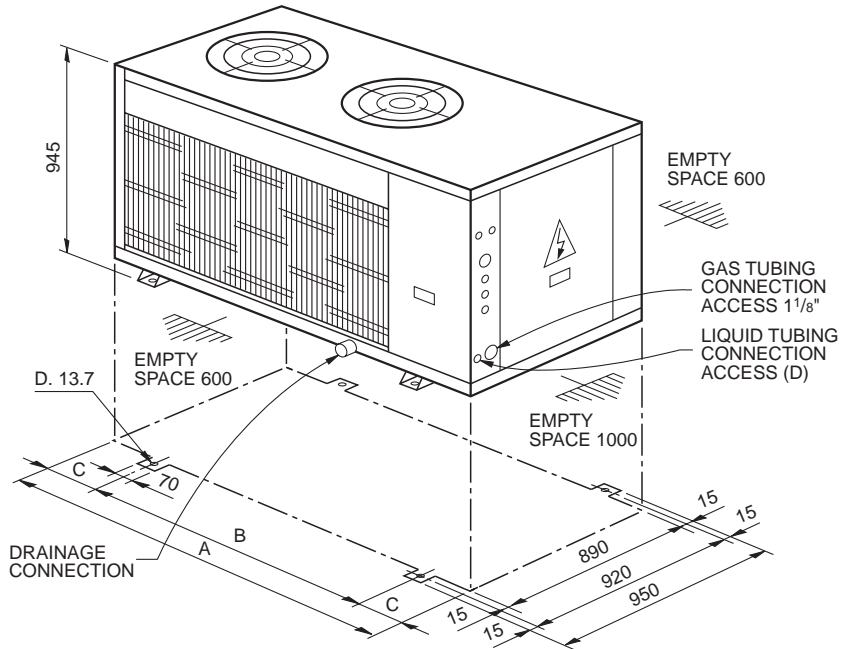

Models	A	B	C	D
SOC-076	1 490	970	260	1/2"
SOC-090	1 775	1 255	260	5/8"
SOC-120	2 150	1 580	285	5/8"

General dimensions mm

SOC-150, 180 & 240

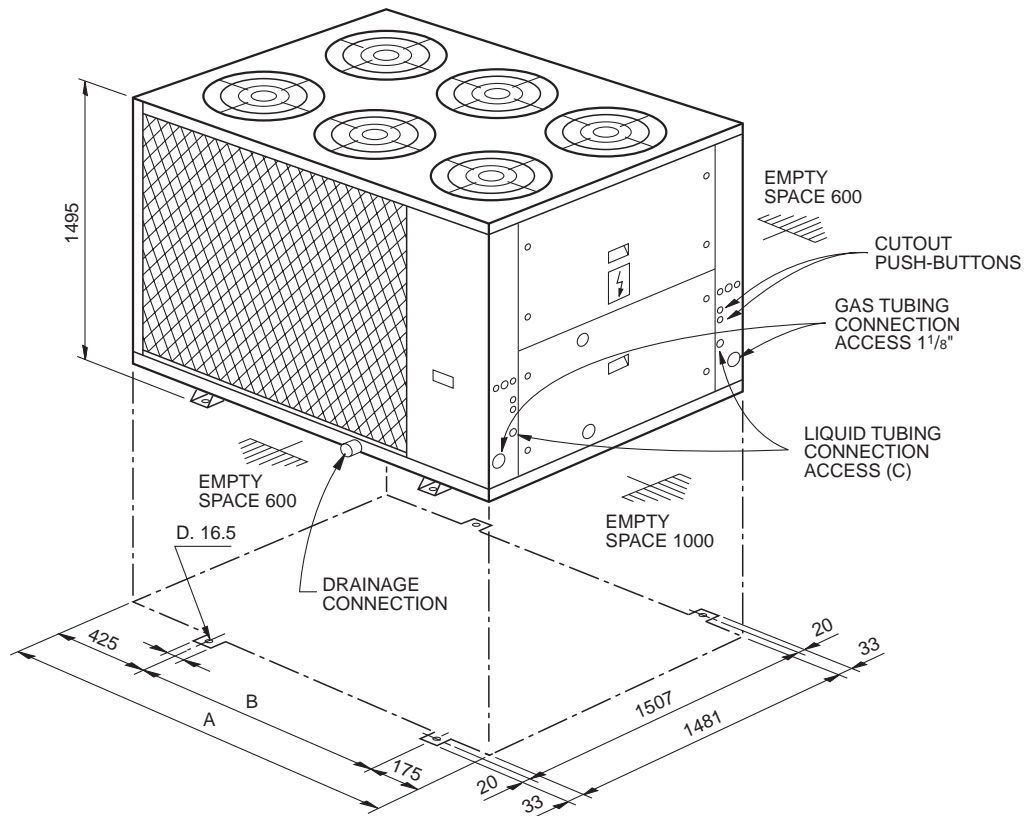

Models	A	B	C
SOC-150	1 690	1 090	1/2"
SOC-180	1 975	1 375	5/8"
SOC-240	2 150	1 550	5/8"

All data subject to change without notice.

DEFINITIVE SHUTDOWN, DISASSEMBLY & DESTRUCTION

This product includes a refrigerant gas under pressure, moving parts and electric components which may be dangerous and cause injury !
All servicing must be done by qualified personnel, wearing protective clothing, in compliance with applicable safety rules.



Read the Manual



Risk of electric shock



Remote-controlled unit
May start up unexpectedly



1. Cut off all electric power-supplies from the unit, as well as from the power supply of the control systems running it. Make sure that all electric cut-off devices are blocked in open position and the town-gas supply valves are in closed position. The power-supply wires and gas pipes may then be disassembled and removed. Consult the technical documentation in order to ascertain the unit's connection points.
2. Transfer all refrigerant from each system component to an appropriate recipient, or use a specially-designed recovery unit. The refrigerant can then be re-used or returned to the manufacturer for destruction/recycling, depending on the case. **It is strictly forbidden to discharge the refrigerant into the atmosphere.** Depending on the case, drain the refrigerant oil from each system into an appropriate recipient and eliminate it in accordance with local applicable regulations relative to hydrocarbon waste products.
3. As a general rule, the solid-block units are to be disassembled and removed in a single piece. Remove all fastening bolts and then raise the items with handling equipment with appropriate lifting capacity. It is absolutely essential to consult the information in the technical documentation as regards the weight and recommended handling procedures. The residual refrigerant oil and spills are to be sponged up and eliminated according to instructions given above.
4. After disassembly, the system components are to be destroyed/drained/put in a recycling dump in accordance with local applicable regulations.